

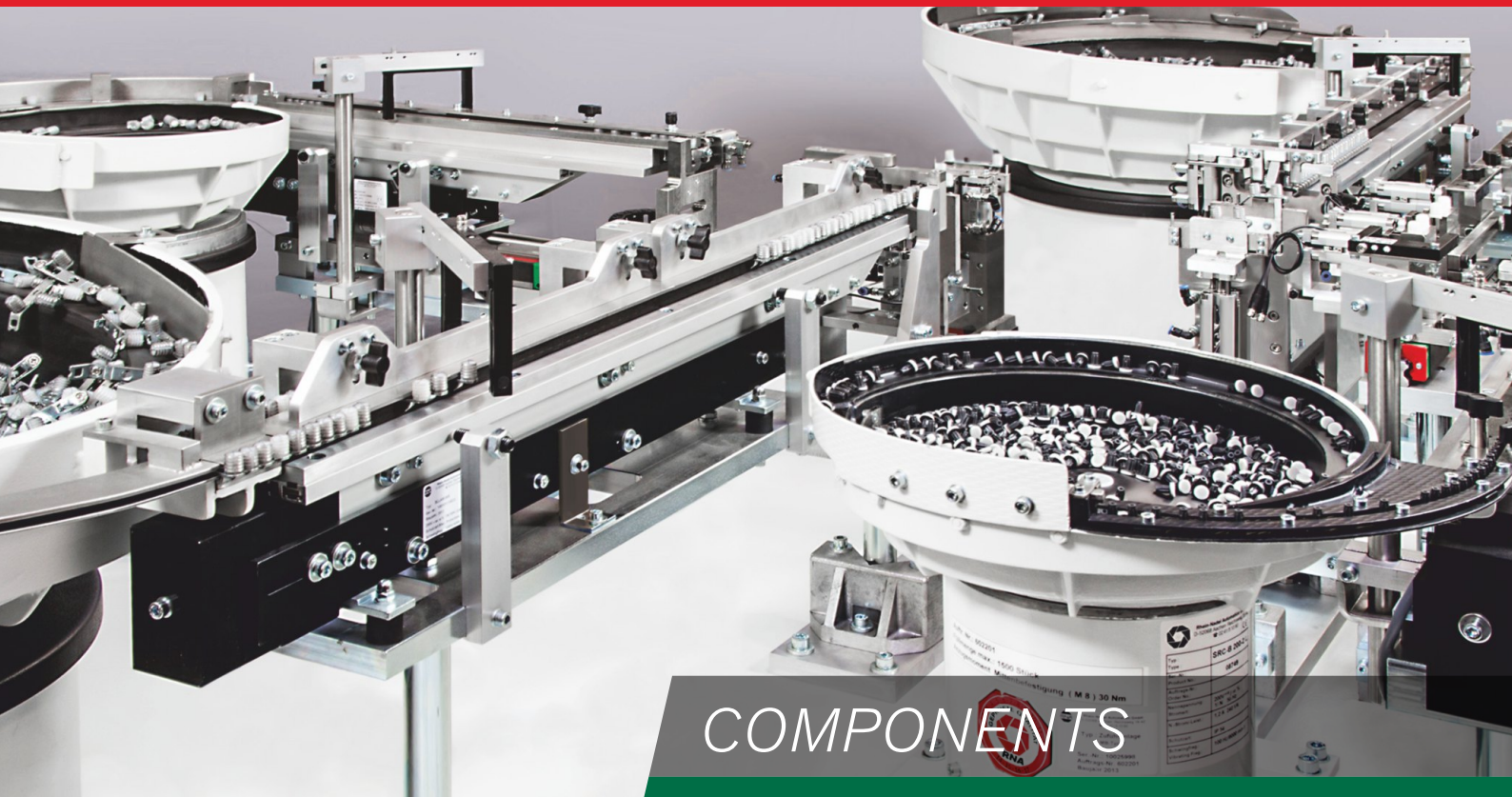

RNA
We handle it.



COMPONENTS

Linear Feeders

- *Drive Units*
- *Feeding Profiles*
- *Stands*
- *Accessories*



Reichsweg 19-23
52068 Aachen
Tel. Sales: +49 (0)241 / 51 09-0
Fax Sales: +49 (0)241 / 51 09-219
Email: vertrieb@rna.de

www.RNA.de

Welcome to RNA Germany – your market leader in the field of feeding technology!

Rhein-Nadel Automation GmbH is a traditional family-owned enterprise that has its head office in Aachen, Germany. With seven production locations and an international network of partners, we are there for you worldwide. For many decades now, our name has stood for top-class performance regarding technology, quality and reliability.

Our two business segments are the development and manufacture of complete custom-made feeding systems and their corresponding components.

With many years experience in the automation and parts handling industry and nearly 2000 complete feeding systems supplied annually, RNA has earned a reputation for the most robust and reliable equipment on the market. Our commitment to research and development maintains our position at the leading edge of feeding technology. We provide an extensive range of the most efficient drive units, controllers and accessories for either standard or special requirements. All equipment is manufactured to the highest standards of quality upon which we have built our reputation. We offer first class service and standard equipment, immediate delivery from stock. Our product range is manufactured to meet the highest demands of the food and pharmaceutical industries and also includes equipment manufactured to UL and CSA standards. Quality has always been of central importance to RNA, with each employee committed to make their own personal contribution to the achievement of quality standards and customer satisfaction. We know that long term success in business can only be achieved by providing high quality equipment, which fulfils the customer's requirements.



Linear feeders from RNA for in line feeding of components and much more

Linear feeders from RNA enable a linear sorting (linear sorting track). They can also be used for the orientation of components and provide higher outputs with a multi-track design. Misorientated components are returned to pre-feeders via a chute and vibration tray. In addition to horizontal conveying of components, linear feeders can be used to handle irregular supplies of parts from upstream equipment, creating a buffer store and smooth flow for further processes.

Another use of linear feeders is to provide the drive unit for vibratory hoppers to store and feed bulk components. The advantage of vibratory hoppers when compared to other methods is the smooth, gentle and trouble-free flow of components with high feeding weights. Further information can be found in our hopper catalogue. RNA linear feeders are renowned for their high feed performance and long tracks in reliability in demanding conditions.

Table of Contents

Subject	see page:
RNA-Linear feeders	page 03
Selection diagram	page 04
Linear feeder 1	
• Series GL	page 06
• Series SLS	page 07
• Series SLK	page 08
• Characteristics and Patent of series SLL and SLF	page 10
• Series SLA 175 and 400	page 11
• Series SLL 175	page 12
• Series SLL 400	page 13
• Series 800 and 804	page 14
• Series SLF 1000	page 16
SLL and SLF series feeding profiles	page 17
Stands 2	page 18
Accessories 3	page 19

Special technical requirements are available on request. All measurements are in millimetres.

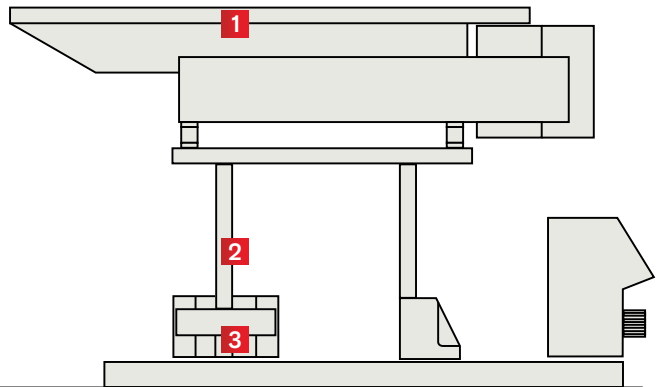

More product catalogues from the RNA range of equipment

Conveyors	
Linear feeders	
Bowl feeders	
Control boxes	
Bulk hoppers	
Step feeders (not shown to the right)	

Colours of catalogues

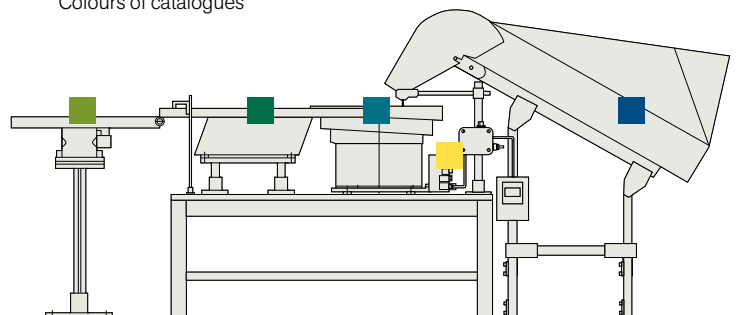

Linear Feeder

Selection

The diagram indicates the most suitable linear feeder type depending on the application.

- SLA 175 | SLA 175 - page 10
- SLS 250 - page 07
- GL-01 - page 06
- GL-1 - page 06
- SLK-N6 | SLK-N6 (G) - page 08
- SLL 400 - Seite 11 | SLA 400 - page 14
- SLL 800 - pages 12/13
- SLL 804 | SLL 804 Z - pages 12/13
- SLF 1000 - page 15
- Special types on enquiry

1. Determine the required track length.
2. Determine the weight of the linear track and other tooling attachments (e.g. sorting chute).
3. Add the weight of components during feed to the weight of the track and attachments.
4. The appropriate RNA feeder is shown in the diagram according to the weight and track length.

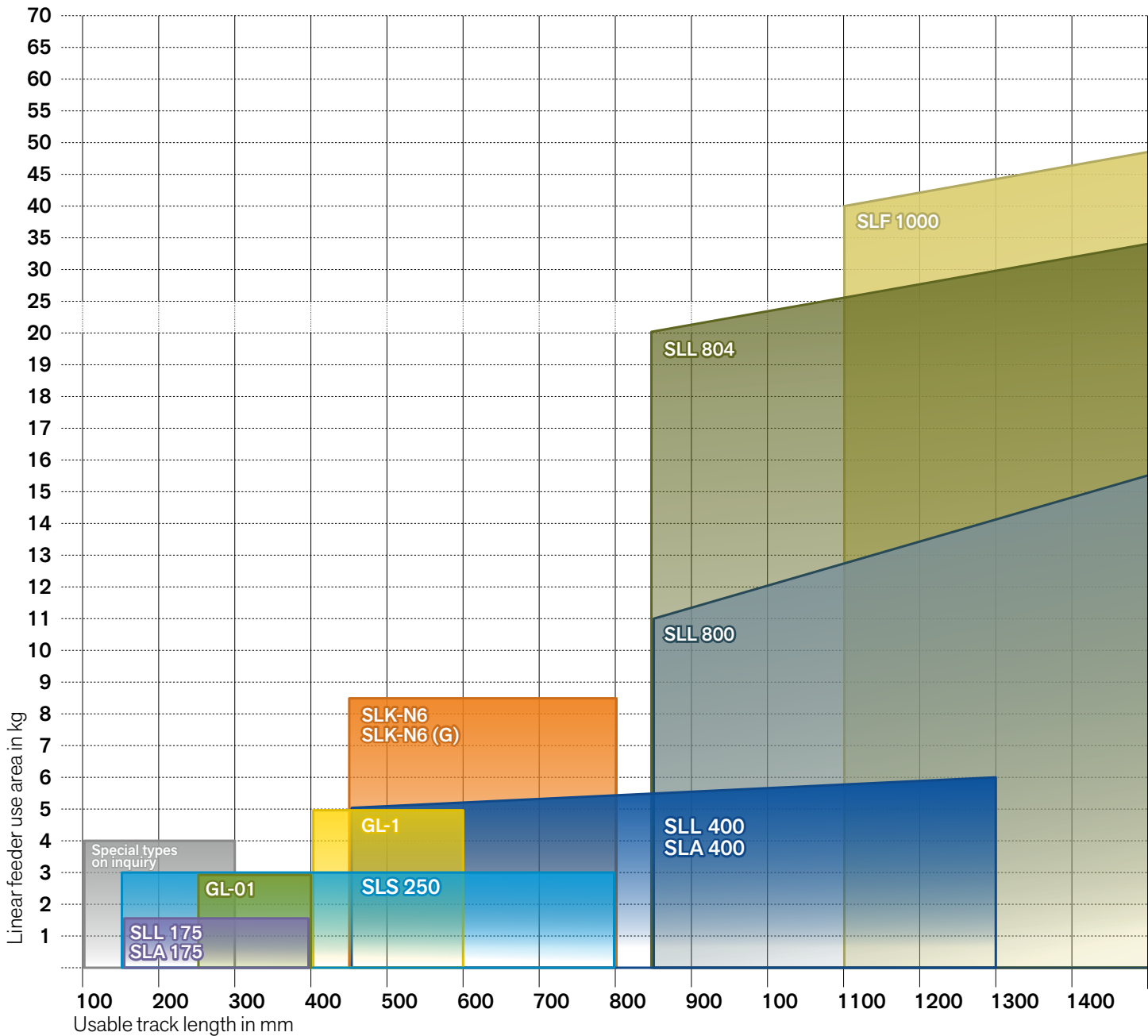

Example



1. The requirement is for a feeding distance of **1800 mm**.
2. Assumption: the track weight for this length is **5,8 kg**.
3. The component weight on this distance of track amounts to **3,2 kg**.
The total weight of components and track is therefore **9 kg**.
4. The diagram suggests **that the linear for a track length of 1800 mm and a total weight of 9kg should be: SLL 800**

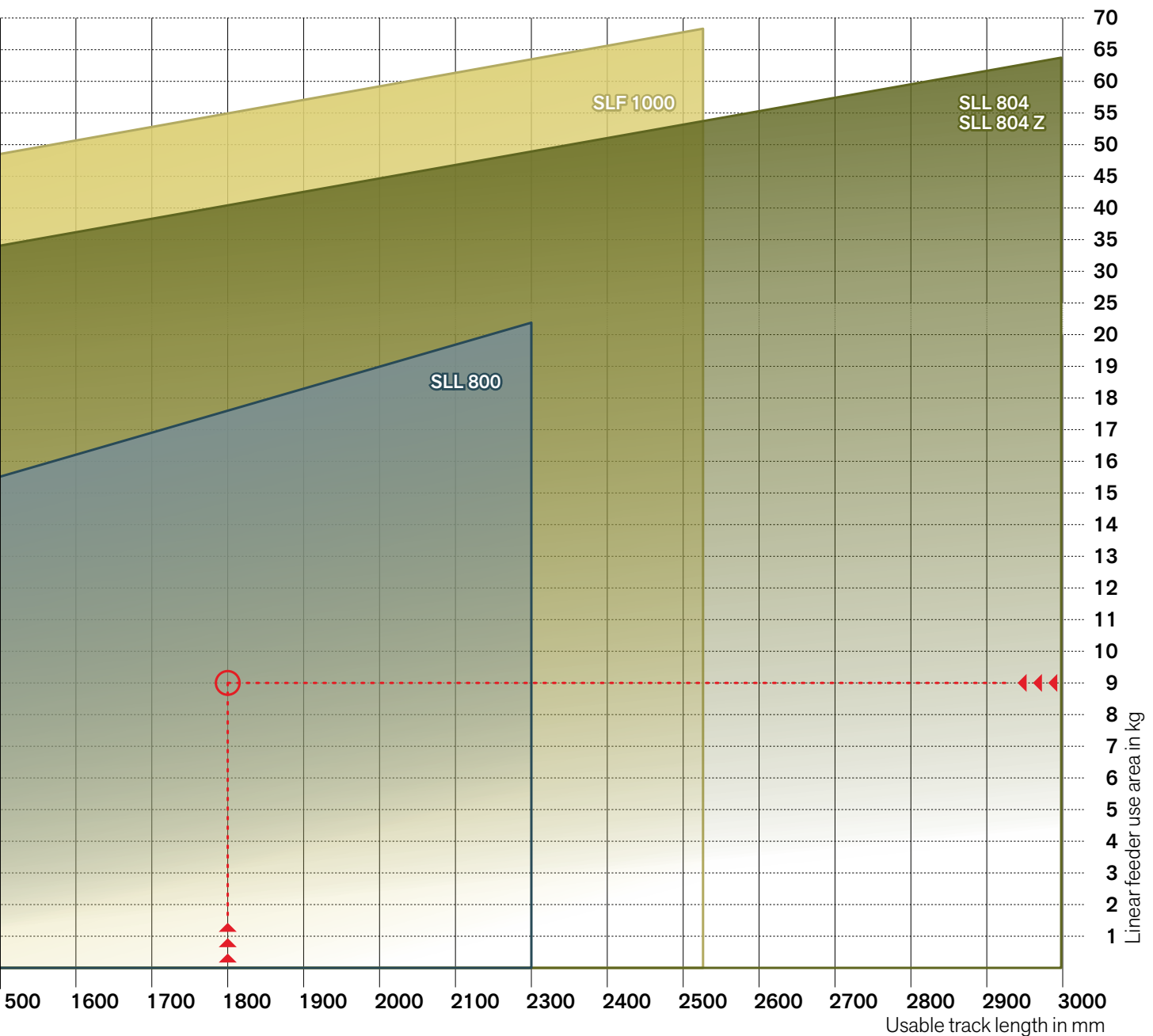

Series GL

The GL series of RNA linear feeders have horizontally fitted springs instead of the traditional vertical arrangement. Feeding resembles more of a sliding motion as opposed to the "projecting" of parts commonly seen on other linear feeders. The smooth and gentle movement provided by this linear means that it is highly recommended when feeding and transferring thin components.

■ ■ Colour table page 04



Type	GL-01	GL-1
A = Vibrator top length	170	320
B = Length of counter mass	170	320
C = Fastening measure	152	285
C1 =	10	12,5
C2 =	40	70
C3 =	4 x M4	4 x M6
F = Total width	ca. 78	117
G = Vibrator top width	58	105
H = Total height	100 +/- 2	100 +/- 2
L = Total length	ca. 245	ca. 410
Weight of the linear feeder drive unit	3,8 kg	8,5 kg
Max. load of the linear track (Including Components)	3 kg	5 kg
Max. track length	400	600
Current input	0,55 (A)	0,87 (A)
Protection class	IP54	IP54
Vibrating frequency	100 Hz	100 Hz
Connection cable length (to control box)	1400	1400
Suitable stand type (see page 18)	UTL 1	UTL 2

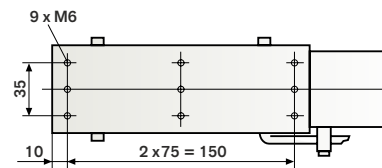
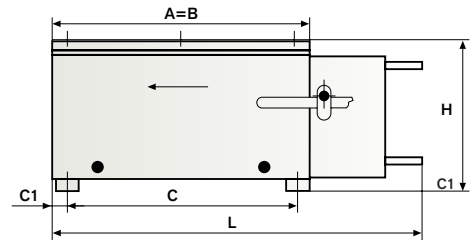

GL-01

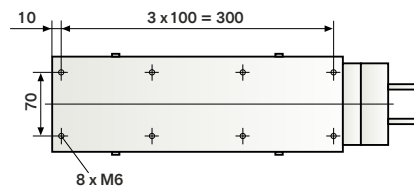
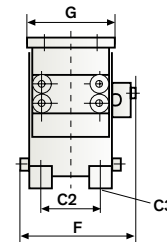

GL-1

Voltage 200V/50 Hz. Available with special voltages 110V/220V and frequencies 50Hz/60Hz. The difference between track length and vibrator top length should be mounted to a ratio of: 1/3 infeed side 2/3 discharge side.

Series SLS

The linear feeder particularly suitable for parts with a highly precise guidance at the change over to separation or vibratory bowl feeder. Owing to the counter vibration principle with the linear feeder, the vibrating forces in the base plate are almost balanced.

■ Colour table page 04

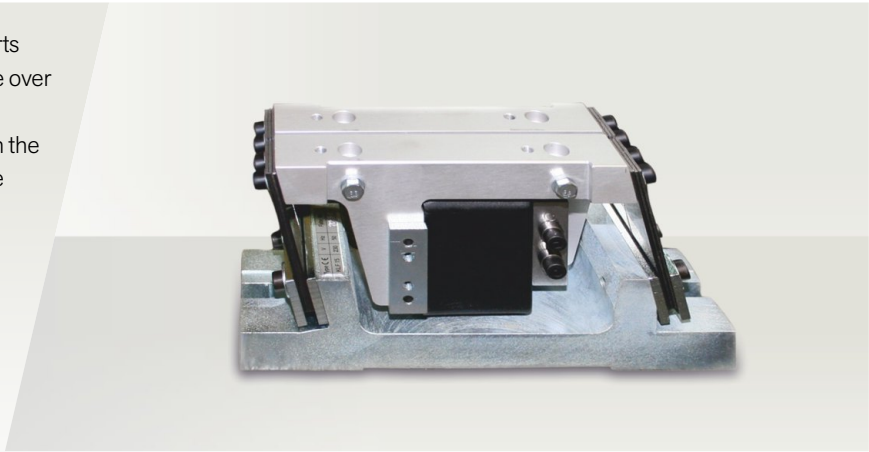

Type	SLS 250	SLS 400	SLS 600	SLS 800
A = (mm)	150 - 250	200 - 400	300 - 600	500 - 800
B = (mm)	122	58	85	150
C = (mm)	17	17	24	29
D1 = (mm)	4,5	4,5	5,5	6,6
D2 = (mm)	4,5	7	9	10
E = (mm)	36	36	50	60
F = (mm)	49	79,7	111,7	139,7
G = (mm)	56	10	30	45
H = (mm)	28	52	88	133
K = (mm)	75	128	177	283
M = (mm)	90	140	200	300
N = (mm)	17,3	-	-	-
Max. weight of feeding track (kg)	0,3	0,65	1,8	3,0
Weight of basic unit (kg)	1,25	2	4,85	12,5
Max. power input (VA)	10	15	25	60
Control box*	ESG 1000	ESG 1000	ESG 1000	ESG 1000

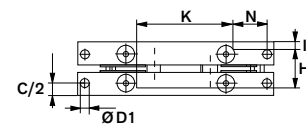
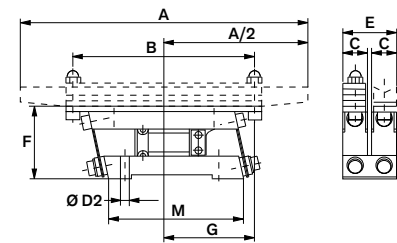

SLS 250-400

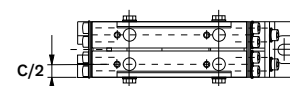
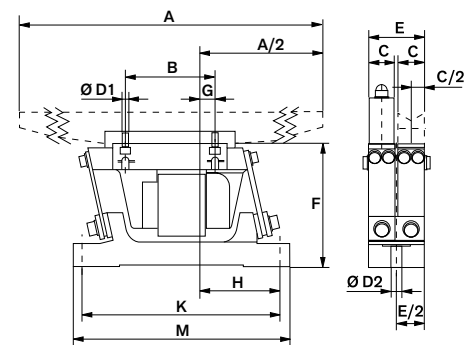

SLS 600-800

Voltage 200V/50 Hz. Available with special voltages 110V/220V and frequencies 50Hz/60Hz.

* Further information you will find in the separate catalogue for RNA control boxes or at www.rnaautomation.com and www.rna.de

Series SLK

The SLK series of RNA linear feeders are suitable for driving vibrating chutes, in which the workpieces are transported. These are used for the linear transport and feeding of workpieces as well as the controlled feeding of bulk components.

Colour table page 04

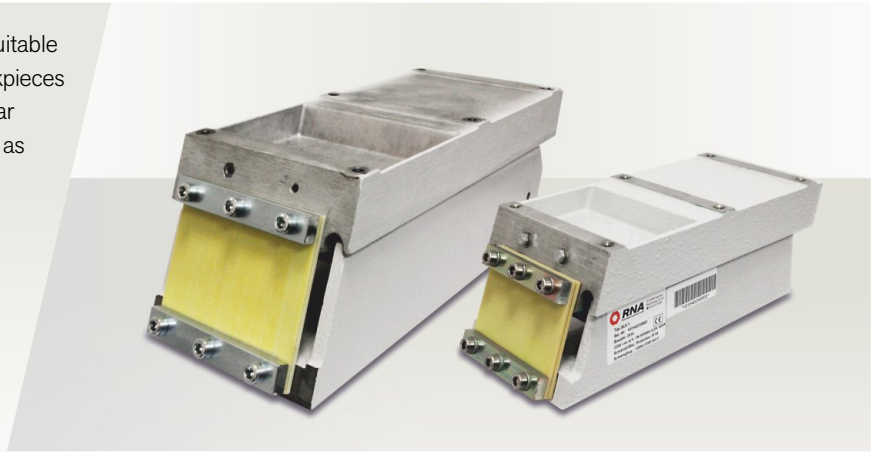

Type	SLK-1	SLK-05	SLK-N6
A = Vibrator top length	247	120	340
B = Length of counter mass	247	210	340
C = Fastening measure	200	180	270
C1 =	45	15	66
C2 =	70	35	100
C3 =	4 x M4	4 x M4	4 x M6
F = Total width	123	50	162
G = Vibrator top width	123	45	162
H = Total height	104	68	143
L = Total length	305	210	426
L1 = Total length	305	210	min. 92, max. 172
Weight of the linear feeder drive unit	7,8 kg	2,8 kg	22,3 kg
Max. load of the linear track (including Components)	1,3 - 3,4 kg	1 kg	5 - 8,5 kg
Max. track length	400	350	800
Current input	0,2 (A)	0,07 (A)	1,25 (A)
Protection class	IP54	IP 54	IP 54
Vibrating frequency	50 Hz	50 Hz	50 Hz
Connection cable (to control box)	2.000	1.500	1.850
Suitable stand type (see page 18)	ULJ2	ULJ2	UTL 2

Voltage 200V/50 Hz. Available with special voltages 110V/220V and frequencies 50Hz/60Hz.

The difference between track length and vibrator top length should be mounted to a ratio of: 1/3 infeed side 2/3 discharge side.

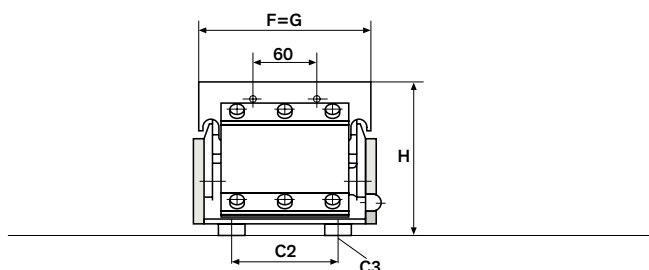
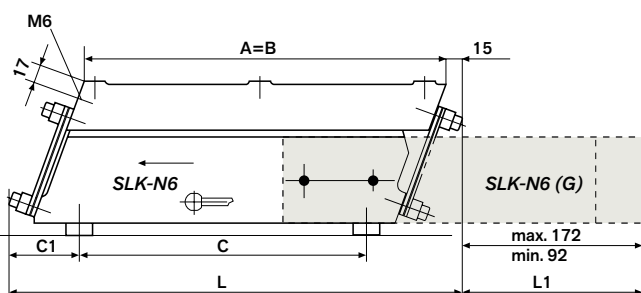

	SLK-N6 (G)	SLK-12
	340	415
	340	415
	270	345
	66	70
	100	140
	4 x M6	4 x M6
	162	203
	162	203
	143	164
	426	515
	min. 92, max. 172	515
	35 kg	33 kg
	5 - 8,5 kg	12-18 kg
	800	1.000
	1,25 (A)	2,2 (A)
	IP 54	IP 54
	50 Hz	50 Hz
	1.850	2.000
	UTL 2	ULJ2

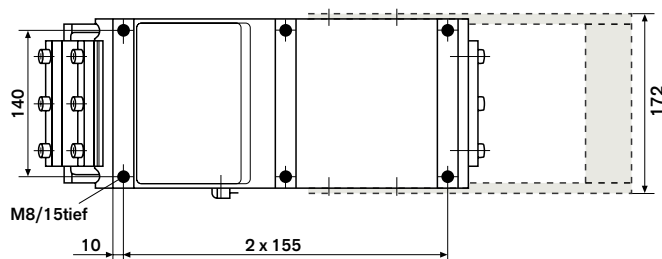

In order to achieve the best performance, we recommend the fitting of counter weights where there is extended track on the discharge side. [SLK-N6 (G)]

Series SLA, SLL and SLF

The RNA linear feeders series SLA, SLL and SLF are renowned for the following three characteristics:

1. A patented adjustment of the spring angle without altering the gap setting
2. Flexible fastening of tooling into a continuous channel.
3. Interchangeable vibrating profiles.
Version B – large
Version S – small



One of the main advantages of the SLA, SLL and SLF series (Pat-No. 4312711-DE) is the patented adjustment of spring angles to maintain the magnet gap setting. The spring angles can be adjusted externally and separately to meet special requirements e.g. a higher projection angle for slightly oily components or a low angle for thin parts. The vibrating profile is designed to allow fixing at any position by way of a continuous channel and is also interchangeable for different mounting widths.

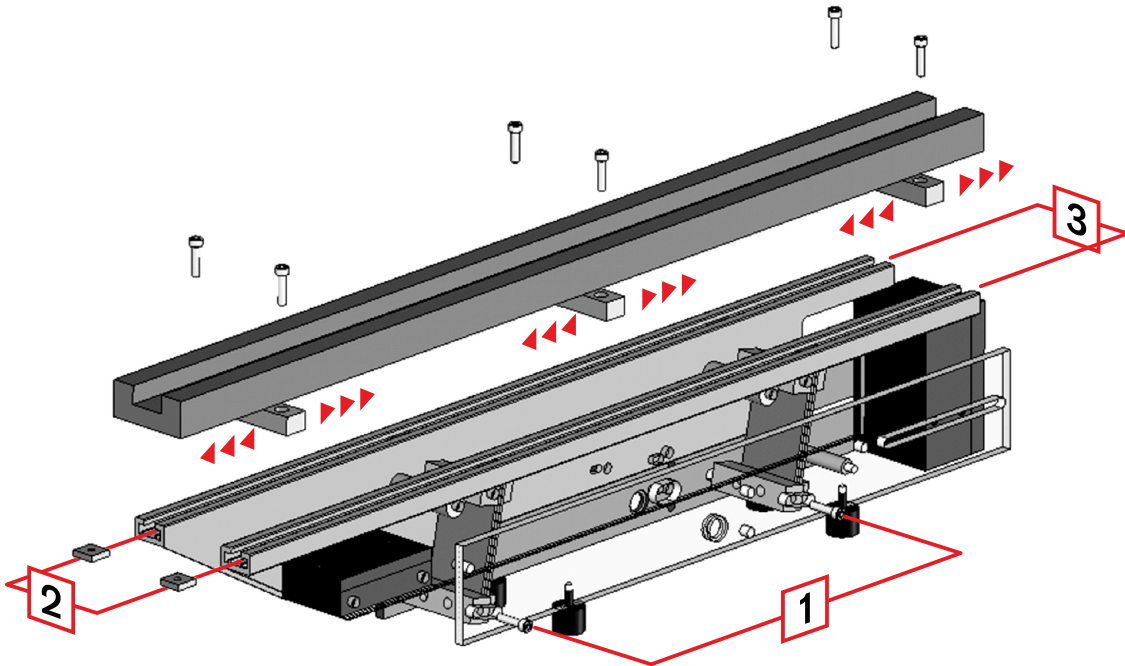

SLA 175 and SLA 400

The linear feeder type SLA ensures a defined and precise interface to bowl and linear feeders or separations. Through a stiff fixation of the linear feeder the SLA shows a steady running behaviour independently from the connected mass of the substructure and therefore, takes no influences from the environment. Lateral oscillation is avoided, resulting in a stable transition with safe feeding, particularly with critical workpiece geometries. The bolt-fixing is completely free of resilient elements and adjusted drilling holes simplify the adjustment of the linear track junction for an accurate positioning. The spring angle can be centrally adjusted without changing the magnet gap.



■ ■ Colour table page 04

Type	SLA 175-225	SLA 400-600
A = Vibrator top length	225 (3x65/M4)	600
B = Length of counter mass	178,5	482
C = Fastening measure	155	400
C1 =	6	10
C2 =	58	82
C3 =	M6/12 tief	M6/12 tief
F = Total width („S“/„L“)	75	102
G = Vibrator top width („S“/„L“)	37/55	66/84
G1 = Mounting dimension („S“/„L“)	25/44	30/64
H = Total height	97	168
L = Total length	268	662
Weight of the linear feeder	2,3 kg	13 kg
Weight of the linear feeder (including work-pieces)	1,2-1,5 kg	5,0-6,5 kg
Max. track length	350	850
Current consumption	70 mA	600 mA
Protection class	IP 54	IP 54
Vibrating frequency	100 Hz	100 Hz
Connection cable length	1.800	1.400

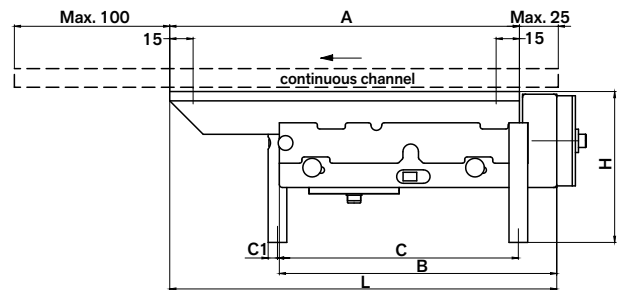

Track fastening Small "S"

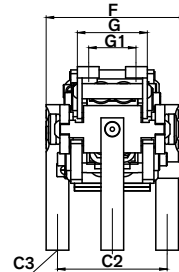

Track fastening Large "L"

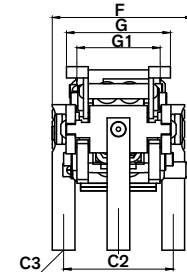

SLA 175-225

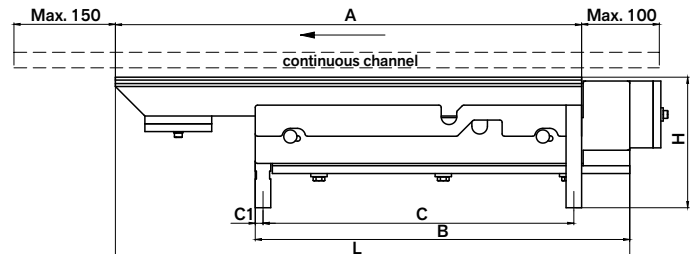

Track fastening Small "S"

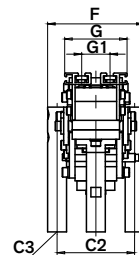

Track fastening Large "L"

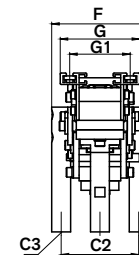

SLA 400-600

SLL 175

The SLL 175 gives the operator the proved advantages of the SLL series also for short tracks (from 175 – 400 mm). The linear feeder type SLL 175 has two main features:

1. Patented adjustable spring angle while retaining the magnet gap
2. Interchangeable vibrating profiles

■ Colour table page 04

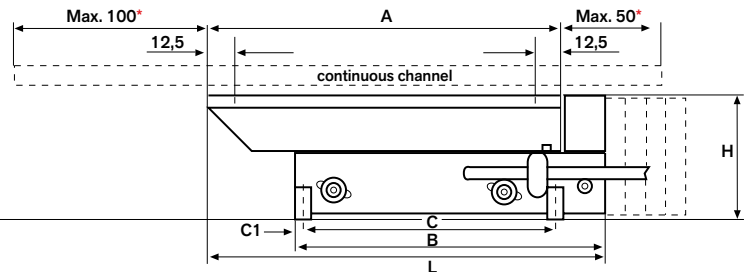

Type	SLL 175-175	SLL 175-250
A = Vibrator top length	175 (3 x 50 / M4)	250 (3 x 75 / M4)
B = Length of counter mass	168	218
C = Fastening measure	125	175
C1 =	4	4
C2 =	67	67
C3 =	M4/4 tief	M4/4 tief
F = Total width ("S"/"L")	82	82
G = Vibrator top width („S"/„L")	36/62	36/62
G1 = Alternative fixing position	20/48	20/48
H = Total height	63	63
L = Total length	211	286
Weight of the linear feeder drive unit	1,2 kg	1,4 kg
Max. load of the linear track (Including Components)	1,3 kg	1,5 kg
Max. track length	325	400
Current Input	70 mA	70 mA
Protection class	IP 54	IP 54
Vibrating frequency	100 Hz	100 Hz
Connection cable (to control box)	1.800	1.800

Track fastening Small "S"

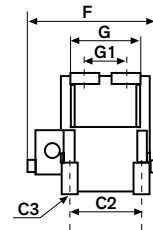

Track fastening Large "L"

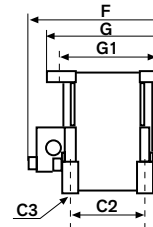

For adjustment additional spring assemblies are enclosed.

In Addition to the advantages of the adjustable spring angles, the flexible fastening and the interchangeable tracks (see page 17) the series SLL 400 and SLL 800 feature an increased track length which ranges from 400 – 3000 mm. Extra spring packs and / or magnets are also available for special applications.

■ Colour table page 04

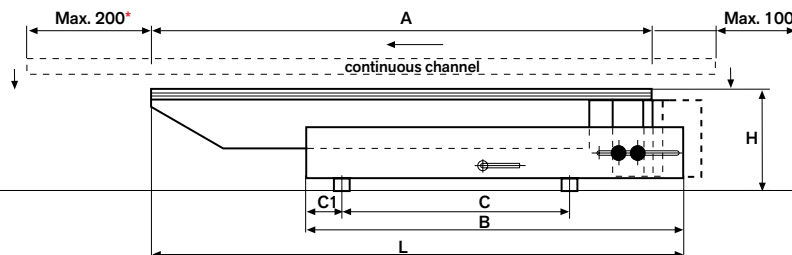

Type	SLL 400-400	SLL 400-600	SLL 400-800	SLL 400-1000
A = Vibrator top length	400	600	800	1000
B = Length of counter mass	300	440	640	790
C = Fixing measure	200	300	450	500
C1 =	10	50	100	200
C2 =	60	60	60	60
C3 =	M4 / 4 tief	M4 / 4 tief	M4 / 4 tief	M4
F = Total width ("S"/"L")	75/84	75/84	75/84	75/84
G = Vibrator top width ("S"/"L")	66/84	66/84	66/84	66/84
G1 = Alternate fixing position	30/64	30/64	30/64	30/64
H = Total height	103	103	103	103
L = Total length	430	630	830	1030
Weight of the linear feeder	6,5 kg	8 kg	10 kg	12,5 kg
Max. load of the linear track (Including work-pieces)	5 kg	6 kg	7 kg	8 kg
Max. track length	700	900	1.100	1.300
Current input	0,55 (A)	0,55 (A)	0,55 (A)	0,55 (A)
Protection class	IP 54	IP 54	IP 54	IP 54
Vibrating frequency	100 Hz	100 Hz	100 Hz	100 Hz
Connection cable length	1.400	1.400	1.400	1.400
Suitable stand type (see page18)	UTL 2	UTL 2	UTL 2	UTL 2

Track fastening Small "S"

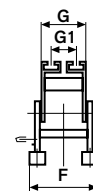

Track fastening Large "L"

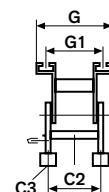

Voltage 200V/50 Hz. Available with special voltages 110V/220V and frequencies 50Hz/60Hz.

*Difference between track length and vibrator top length should be mounted to a ratio of: 1/3 infeed side 2/3 discharge side. For a more stable position when using vibratory superstructures on the linear track, the SLL 400 can also be delivered with a mounted wider setting.

For adjustment additional spring assemblies are enclosed.

For track mounting every 100 mm two sliding blocks M5 are made available.

SLL 800 and SLL 804

The SLL 800 and 804 have the same characteristics as the SLL series. The advantages of the SLL 400 series (see page 13), are the same for the SLL 800. However, higher track weights can be achieved by using a heavier counter mass and higher performance magnets. The SLL 800 is available with vibration free mounting for use in special applications.

■ ■ Colour table page 04

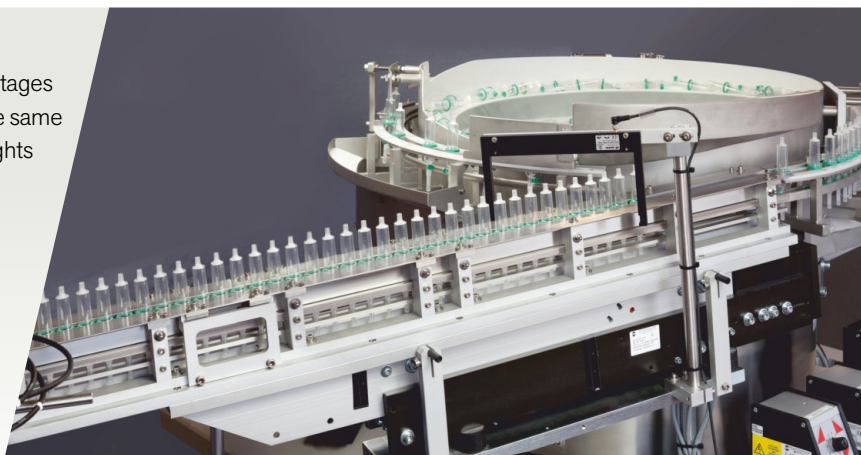

Type	SLL 800-800 SLL 804-800	SLL 800-1000 SLL 804-1000	SLL 800-1200 SLL 804-1200	SLL 800-1400 SLL 804-1400	SLL 800-1600 SLL 804-1600
A = Vibrator top length	800	1000	1200	1400	1600
B = Length of counter mass	600	752	904	1056	1210
C = Fastening measure	300	450	600	750	900
C1 =	120	122	124	126	120 130
C2 =	83 87	83 87	83 87	83 87	83 87
C3 =	M6/8 M8	M6/8 M8	M6/8 M8	M6/8 M8	M6/8 M8
F = Total width	120 127	120 127	120 127	120 127	120 127
G = Vibrator top width ("S"/"L")	70/120	70/120	70/120	70/120	70/120
G1 = Alternative fixing position	40/90	40/90	40/90	40/90	40/90
H = Total height	162 172	162 172	162 172	162 172	162 172
L = Total length	850	1050	1250	1450	1650
Weight of the linear feeder drive unit	18,5 kg 21,5 kg	20,5 kg 24,5 kg	23 kg 27,5 kg	24 kg 29,5 kg	31,5 kg 39,5 kg
Max. load of the linear track (Including Components)	ca. 11 kg ca. 21 kg	ca. 13 kg ca. 25 kg	ca. 15 kg ca. 28 kg	ca. 17 kg ca. 32 kg	ca. 19 kg ca. 36 kg
Max. track length	1.100	1.300	1.500	1.700	1.900
Current Input	1,25(A)	1,25(A)	1,25(A)	1,25(A)	1,25(A) 2,5 (A)
Protection class	IP 54	IP 54	IP 54	IP 54	IP 54
Vibrating frequency	50 Hz	50 Hz	50 Hz	50 Hz	50 Hz
Connection cable (to control box)	1.750	1.750	1.750	1.750	1.750
Suitable stand typ (see page 18)	UTL 2	UTL 2	UTL 2	UTL 2	UTL 2

For adjustment additional spring assemblies are enclosed.
For track mounting every 100 mm two sliding blocks M6 are made available.

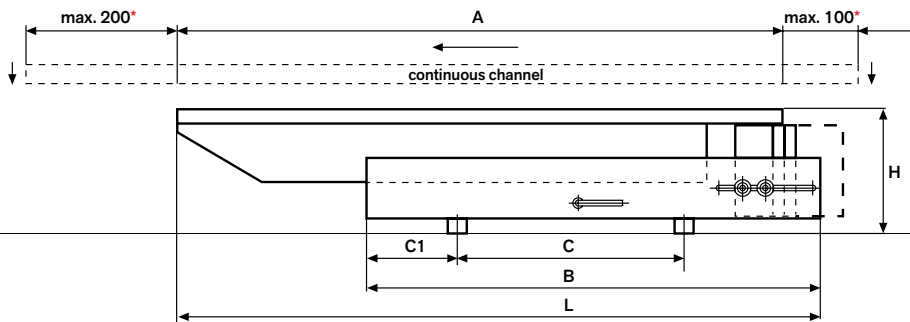

Track fastening Small "S"

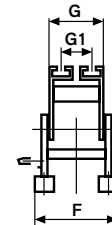

Track fastening Small "S"

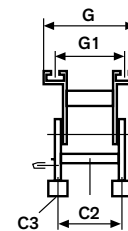

	SLL 800-1800 SLL 804-1800	SLL 800-2000 SLL 804-2000	SLL 804-2400	SLL 804-2800
	1800	2000	2400	2800
	1360	1550	1950	2350
	1050	1200	1500	1900
	130	170	270	270
	83	83		
	87	87	87	87
	M6/8	M6/8		
	M8	M8	M8	M8
	120	120		
	127	127	127	127
	70/120	70/120	70/120	70/120
	40/90	40/90	40/90	40/90
	162	162		
	172	172	172	172
	1850	2050	2450	2850
	34 kg	39,5 kg		
	43 kg	49,5 kg	63 kg	76 kg
	ca. 21 kg	ca. 23 kg		
	ca. 40 kg	ca. 44 kg	ca. 51 kg	ca. 62 kg
	2.100	2.300	2.700	3.000
	1,25(A)	1,25(A)		
	2,5 (A)	2,5 (A)	2,5 (A)	2,5 (A)
	IP 54	IP 54	IP 54	IP 54
	50 Hz	50 Hz	50 Hz	50 Hz
	1.750	1.750	1.750	1.750
	UTL 2	UTL 2	UTL 2	UTL 2

Voltage 200V/50 Hz. Available with special voltages 110V/220V and frequencies 50Hz/60Hz.

* Difference between track length and vibrator top length should be mounted to a ratio of: 1/3 infeed side 2/3 discharge side.

Series SLF 1000

RNA linear feeders, series SLF 1000 are suitable for track weights up to 50 kg. When using these drive units for bulk hoppers, load weights up to 200 kg are possible. The high magnet performance of the SLF 1000-1500 is especially suitable for these hopper applications (e.g. multi-track feeding).

■ Colour table page 04

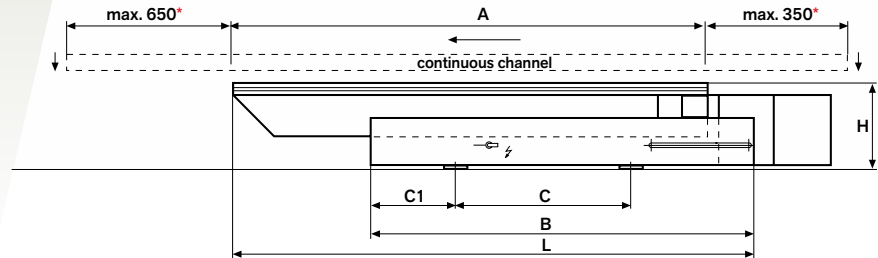

Type	SLF 1000-1000	SLF 1000-1500
A = Vibrator top length	1000	1500
B = Length of counter mass	800	1300
C = Fastening measure	370	870
C1 =	170	170
C2 =	130	130
C3 =	M10/10 tief	M10/10 tief
F = Total width ("S"/"L")	208	208
G = Vibrator top width ("S"/"L")	204/244	204/244
G1 = Alternative fixing position	140/204	140/204
H = Total height	178	178
L = Total length	1100	1600
Weight of the linear feeder drive unit	62 kg	80 kg
Max. load of the linear track (Including Components)	ca. 40 kg	ca. 70 kg
Max. track length	2000	2500
Current Input	2,5 (A)	5 (A)
Protection class	IP 54	IP 54
Vibrating frequency	50 Hz	50 Hz
Connection cable (to control box)	1.750	1.750
Suitable stand type (see page17)	UTL 2	UTL 2

Track fastening
Small "S"

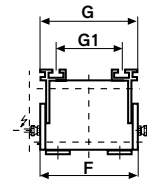

Track fastening
Large "L"

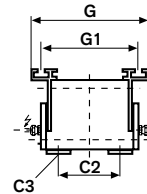

Voltage 200V/50 Hz. Available with special voltages 110V/220V and frequencies 50Hz/60Hz.

* Difference between track length and vibrator top length should be mounted to a ratio of: 1/3 infeed side 2/3 discharge side.

For adjustment additional spring assemblies are enclosed.

For track mounting every 200 mm two sliding blocks M8 are made available.

SLA, SLL and SLF series

Feeding Profiles

The adjustable vibrating profile of the SLA, SLL and SLF series allows either a narrow or wide feed on the linear track. The continuous channel on the vibrating profile allows the track to be fastened wherever required. This flexibility allows the linear feeder to be easily tuned for smooth and continuous feeding.

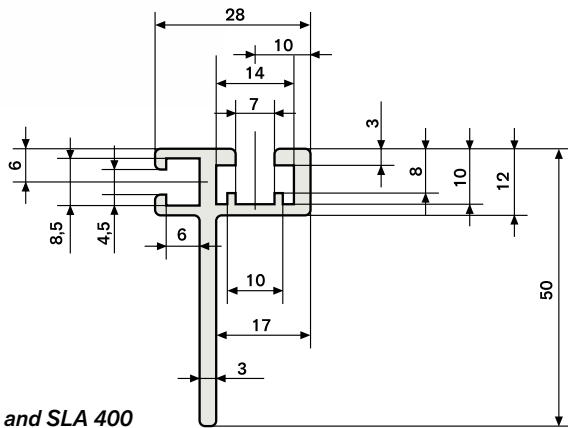
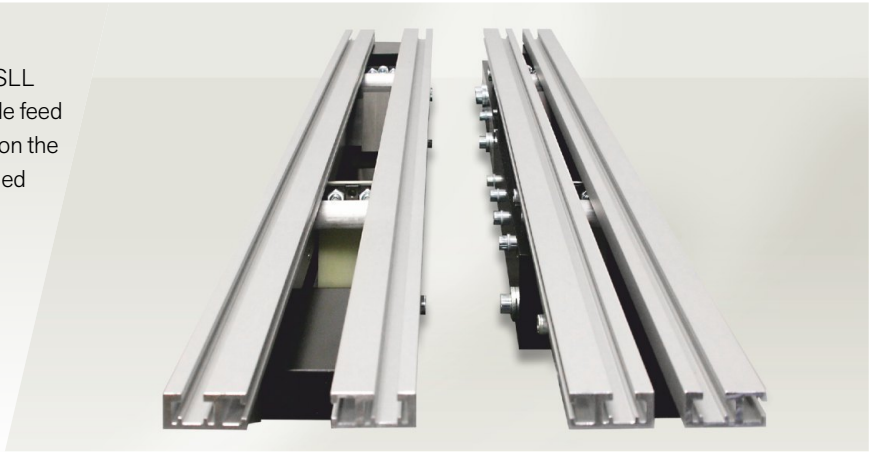

SLL 400 and SLA 400

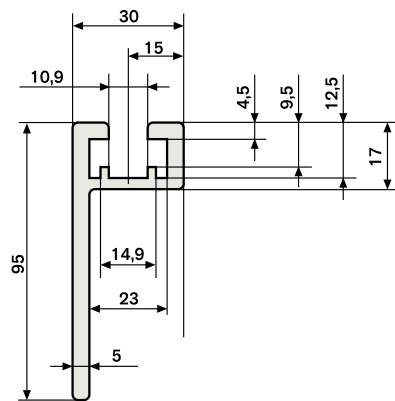

SLL 800 and 804

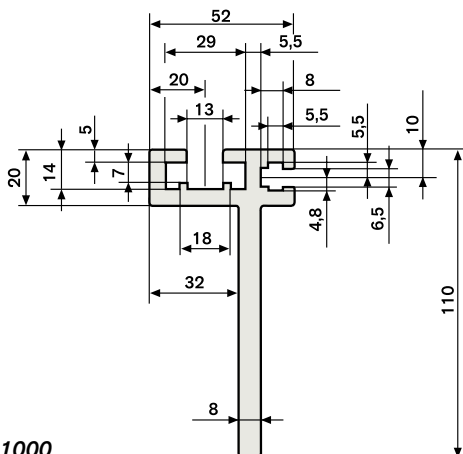

SLF 1000

Stands for

RNA linear feeders

UTL stands allow easy assembly of RNA linear feeders to a base plate.

They consist of:

- Pedestal stand
- Column
- Top plate

These units are modified to suit the linear feeders and supplied with drill holes and threads for easy assembly.

Stand UTL 1

The stand UTL 1 is suitable for the assembly of SLK-05 and GL-01 linear feeders. The column length is 300 mm and can be altered as required. Height adjustment is by means of a set-screw. Adjustment on the pedestal stand is +15 mm.



Stand ULJ

The stand ULJ is suitable for the assembly of GL-1, SLK-N6, SLL and SLF linear feeders. The column length is 300 mm and can be altered as required. The height adjustment of the linear feeder takes place with a combination of a clamping plate and adjustment screw in the column. Adjustment on the pedestal stand is +10 mm. By taking off the clamping plate, the linear feeder can be moved to the side. A full lift-out is not necessary.

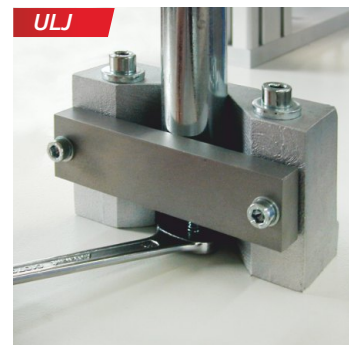

Wider setting for added stability UTL 3

If disproportionately large vibratory superstructures (e.g. multiple linear tracks) are fitted on the linear feeder Type SLL 400, the stability of the linear feeder can be considerably increased by mounting the installation extension Type UTL 3. Critical transitions from or to the linear feeder are also stabilised.

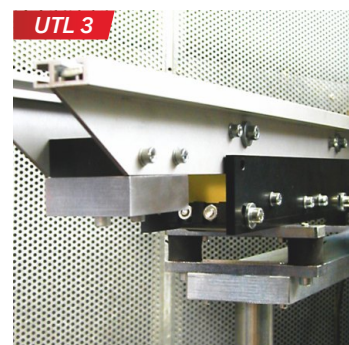

Please state the installed linear feeder type when ordering.

Besides the complete product range for linear feeders available on stock for the series GL, SLK, SLS, SLA, SLL and SLF, special models and accessories are available upon request.

Mounting Plate:

The mounting plate allows an easy absorption of RNA linear feeders incl. accessories, such as sensors or wider settings. All bore holes necessary for mounting are already present. In addition, two notches are incorporated for the accessibility to the spring packages.

Wider Setting:

With the help of a wider setting including the mounted shock absorbers the stability of large vibrating structures is remarkably increased. They are designed for the different types of RNA linear feeders and are ready to be fixed at the mounting plate.

Lateral vibration limit:

The lateral vibration limit is applied during long or elevated vibrating structures as well as for critical transitions to other components. It consists of a holder and an adjustment for limiting the lateral vibration of the RNA linear feeder and is ready for mounting on the mounting plate.

Stand:

The stand serves as a holding fixture for the column on which the mounting plate is attached. With a clamping screw the column can be adjusted with an adjustment range of 15mm, in order to enable an impeccable level transition on RNA linear feeders.

Mounting column:

The mounting column has a length of 300 mm and can be adjusted if needed. It can be mounted at the bottom with an adjustable stand. On the column the mounting plate is mounted, which is already provided with fixing holes and that serves for installing the RNA linear feeder.

Sensor holder:

The sensor holder is designed to hold sensors of a buffer control on a linear track. It is already prepared for mounting on the mounting plate and can be optimally adjusted by a large adjustment range to the local conditions of the RNA linear feeder.

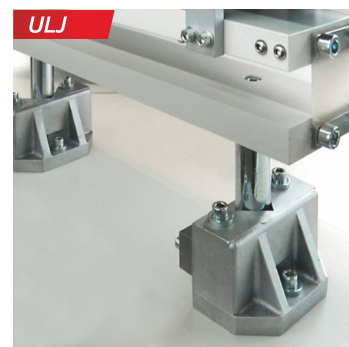

Stand adjustable in height



RNA Group

Headquarter
Production and Sales

Rhein-Nadel Automation GmbH
Reichsweg 19-23
D-52068 Aachen

Tel. Vertrieb:
+49 (0) 241-5109-0
Fax Vertrieb:
+49 (0) 241-5109-219
Email:
vertrieb@rna.de
www.RNA.de



Production and Sales
Focus: pharmaceutical industry

PSA Zuführtechnik GmbH
Dr.-Jakob-Berlinger-Weg 1
D-74523 Schwäbisch Hall
Tel.: +49 (0) 791 9460098-0
Fax: +49 (0) 791 9460098-29
Email: info@psa-zt.de
www.psa-zt.de



Production and Sales

RNA Automation Ltd.
Hayward Industrial Park Tameside Drive,
Castle Bromwich, Birmingham, B35 7AG
Großbritannien
Tel.: +44 (0) 121 749-2566
Fax: +44 (0) 121 749-6217
Email: RNA@RNA-uk.com
www.rnaautomation.com



Production and Sales

HSH Handling Systems AG
Wangenstr. 96
CH-3360 Herzogenbuchsee
Schweiz
Tel.: +41 (0) 62 956 10-00
Fax: +41 (0) 62 956 10-10
Email: info@handling-systems.ch
www.handling-systems.ch



Production and Sales

Pol. Ind. Famades C./Energia 23
E-08940 Cornellà de Llobregat (Barcelona)
Spanien
Tel.: +34 (0)93 377-7300
Fax: +34 (0)93 377-6752
Email: info@vibrant-RNA.com
www.vibrant-RNA.com
www.vibrant.es

www.RNA.de

